



ENGLISH
DHV0067 Rev00

HVD Diagnostics, Inc.

North and South America
271 Rope Mill Pkw, Ste 2
Woodstock, GA30188
USA

Tel. +1 (678) 445 2555
Fax +1 (678) 445 2557

www.hvdiagnostics.com
sales@hvdiagnostics.com

HV Diagnostics Sarl

Africa, Asia, Australia, Middle
East

www.hvdsa.com

Subject to alternations-
errors excepted
Illustrations are not binding

HVA120

User Manual



High Voltage Test System



Table of Contents

1	FORWARD	3
1.1	Regarding this Document.....	3
1.2	Documentation Conventions.....	4
1.3	Legal Considerations.....	5
2	SAFETY	6
2.1	General Safety	6
2.2	Work Safety	6
2.3	Appropriate Applications.....	8
2.4	Operator Qualifications.....	8
3	GENERAL DESCRIPTION	9
3.1	Technical Specifications.....	9
3.2	Design Features	10
3.3	Materials.....	11
4	DESIGN AND CONSTRUCTION	13
4.1	Control Elements.....	13
4.2	User Interface	16
4.3	Instrument Set-up.....	17
4.4	Operation Modes.....	19
5	TEST PROCEDURE	22
5.1	Equipment Set-up.....	22
5.2	Manual Test Mode	24
5.3	Automatic Test Mode	28
5.4	Interrupting a Test.....	35
6	REPORTING PROCEDURE	36
7	DISCONNECTION PROCEDURE.....	41
8	INSTRUMENT CARE.....	43
9	ACCESSORIES	44
10	GLOSSARY AND ABBREVIATIONS	45
11	DECLARATION OF CONFORMITY.....	46



1 Forward

Purpose

This operating manual serves to ensure the proper and safe use of the HVA test instrument.

1.1 Regarding this Document

Target User

This operating manual is designed to inform various user groups. The scope and depth of the information provided may not be appropriate for all users. However, it is important that all users familiarize themselves with this document in full. The following is a guideline indicating the most significant information as a function of the user's responsibilities.

User	Responsibilities	Focus
HVA Operator	<ul style="list-style-type: none">• To connect the equipment• To carry out manual or pre-programmed test sequence• To verify validity of HVA application• To adjust instrument settings• To program automatic test sequences in accordance with particular testing standards	All Sections Particular focus on all safety messages
Procurement, Management	<ul style="list-style-type: none">• To assure that the workplace is safe and has all required equipment• To assure that HVA operators are qualified technicians• To assure that operators fulfil their responsibilities	Particular focus on safety messages and information regarding general product description.

Safekeeping



NOTICE

This manual should always be on hand when using the HVA test instrument



1.2 Documentation Conventions

The following explain the **symbols**, and **safety messages** found in this document. The employment of safety symbols and signal words are according to the American National Standards Institute standard ANSI Z535.6 "Product Safety Signs and Labels".

Safety Messages

Danger

DANGER

Indicates a hazardous situation which if not avoided will result in death or serious injury

Warning

WARNING

Indicates a hazardous situation which if not avoided could result in death or serious injury.

Caution

CAUTION

Indicates a hazardous situation which if not avoided could result in minor or moderate injury.

Notice

NOTICE

Indicates suggested practices to protect equipment and property.

Symbols



Yellow triangle, framed in black: Used to indicate a potential hazard. Only used in conjunction with description of the possible hazard! Detailed symbol may correspond to this specific hazard.



Red outlined circle with red diagonal line: Used to indicate forbidden practices. The described handling practice must not be carried out!



Blue circle with white exclamation mark: Used to indicate recommended precautionary measures or a situation that can lead to property damage.



1.3 Legal Considerations

Warranty

HV Diagnostics provides a one-year warranty from the original purchase date of instrument for all necessary parts and labor. This warranty is void in the event of abuse, incorrect operation or use, unauthorized modification or repairs, or failure to perform the specified maintenance as indicated in this operation manual. This warranty does not include normal consumable items such as lamps, paper rolls, printer ribbons, batteries or other auxiliary items.

This warranty and our liability are limited to replacing or repairing defective equipment, at our discretion. Equipment that is returned to HV Diagnostics must be packed in original packaging. All shipped items must be prepaid and insured. No other warranties are expressed or implied.

Contact Information

HV Diagnostics, Inc	HV Diagnostics Sarl
271 Rope Mill Pkwy, Ste 2	Africa, Asia, Australia
Woodstock, GA 30188	Middle East
USA	www.hvdsa.com
T: +1 (678) 445 2555	
F: +1 (678) 445 2557	
North and South America	
www.hvdiagnostics.com	
sales@hvdiagnostics.com	

Copyright

©2013 HV Diagnostics
All rights reserved.

No part of this publication may be reproduced, transmitted, stored, or translated in hardcopy or electronic form without the written consent of HV Diagnostics.

Your opinion matters!

Your comments and suggestions are of value. We are dedicated to supporting your needs. Offering you optimal documentation is part of our promise of quality.

Improvement suggestions regarding this manual may be sent to:

sales@hvdiagnostics.com

Thank you for your feedback!



2 Safety

Safety is **priority!** Respect all **safety information**; only use the HVA for **appropriate applications** and ensure that operators possess the required **operator qualifications**.

2.1 General Safety



NOTICE

Operation Manual

Before carrying out any high voltage test with this instrument, read this Operating Manual in its entirety.

2.2 Work Safety



DANGER

Electric Shock Hazard

Never assume that equipment is safe to handle without using the necessary safety equipment and earthing procedures.

- All procedures must comply with local safety regulations
- Always treat exposed connectors and conductors as potential electric shock hazards.
- DUT must be earthed, de-energized and isolated from all power sources.
- All auxiliary electrical apparatus such as switchgear, surge arresters etc. must be isolated from the test power source and the DUT.
- All cables and connectors must be inspected for damage before use. Damaged equipment must not be used.
- Earth connections must be made first and removed last!
- DUT must be discharged and earthed before disconnecting the test lead.
- Avoid testing alone. In the event of an emergency another person's presence may be essential.



DANGER

Authorized Personnel Only

The test area must be secured to keep non-qualified personnel off the premises!

- Signs must warn all persons of the high voltage test area.
- Only qualified electrical technicians should have access to the test area.
- Other persons must be accompanied by qualified electrical technicians and must be informed of the risks involved.



WARNING

Radiation Hazard

Testing vacuum bottles, above their voltage rating, with DC can produce dangerous X-rays.



NOTICE

Equipment Handling

DUT must have clean connections.

Test instruments must only be repaired or modified by authorized HVD personnel.



NOTICE

If required according to local safety regulations

Wear high voltage gloves when handling high voltage cables and equipment.



2.3 Appropriate Applications

The HVA test instrument is designed to perform high voltage insulation testing of various types of highly capacitive loads.

Appropriate DUTs

DUT Type	Examples
Cables	<ul style="list-style-type: none">• Extruded cables (e.g. XLPE)• Laminated cables (e.g. PILC)• Insulated cables• Cable jacket / sheath
Other highly capacitive loads	<ul style="list-style-type: none">• Generators• Switchgear• Transformers• Rotating machines• Insulators• Bushings

Appropriate Measurements

Measurement	Examples
Test	<ul style="list-style-type: none">• Capacitance• Resistance• Dielectric breakdown voltage• RMS current• Applied voltage



NOTICE

Other Applications

Before proceeding, contact HV Diagnostics to validate appropriate use!

2.4 Operator Qualifications

HVA operators must be **qualified electrical technicians!** Proof of necessary qualifications for working in high voltage domain is mandatory. It is highly recommended that operators have completed an emergency rescue training program.



3 General Description

3.1 Technical Specifications*

Characteristic	HVA120
Input Supply Voltage	210-240V; 50/60 Hz; ±10%...
Input Supply Power	3kVA
Output Voltage [Max.]	VLF Sinewave: 120kV rms , 85kV Peak VLF Squarewave: 120kV DC [+/-]:+90 kV /-120kV
Output Current [Max.]	60mA (Resolution 1µA) Accuracy: ±1 %
Output Frequency	0.01 Hz -0.1Hz in 0.01 Hz increments
Sheath Test	max. Test Voltage: 10 kV, Duration: 1 min – 15 min Trip Current: 0.1 mA – 5.0 mA
Sheath Fault Location Mode ²	max. Test Voltage: 10 kV, Duration: 1 min – 60 min Pulse/Period: 1:3 / 4 s, 1:5 / 4 s, 1:5 / 6 s, 1:9 / 6 s
Frequency optimization	Yes
Output Load Capacity	At Full rated voltage at 0.1Hz: 1µF Max. at reduced frequency and or reduced voltages: 5µF
Metering	Current: 1µA ±1% Resolution Voltage: 0.1kV ±1% Resolution Capacitance: 0.1nF - 20µF Resistance: 0.1 MΩ -20GΩ
Output Duty	Continuous
Test Modes	Manual Automatic
Output Modes [Load independent, symmetrical]	VLF AC Sinewave VLF AC Squarewave DC [+ or – polarity] Vacuum Bottle Testing Sheath Test Sheath Fault Location
Arc Management Modes	Fault Conditioning Mode: Burn on Arc Fault Trip Mode: Trip Out on Arc
Computer Interface	RS232 (standard) USB Flash Memory Module (optional)
Record Storage	Built in Memory: up to 50 reports , 40 Test sequences USB Memory Flash drive: Unlimited
PC Software [included]	HVA Control Center for Windows XP / Vista /
Weight	181kg
Dimensions	790 x 445 x 740 mm (Excl. Carry Handle)
Environment	Storage Temperature: -25°C to 70°C (-13F to 158F) Operation Temperature: -5°C to 45°C (23F to 113 F) Humidity: 5-85% non condensing

*Technical Specifications are subject to change. HV Diagnostics reserves the right to modify values in accordance with future HVA development.



3.2 Design Features

To assure that the workplace is safe and that operators can fulfil their responsibilities with ease, the HVA provides the following features.







Feature	Purpose / Application	Advantage
Optimized Frequency Selection / Automatic load measurement	<ul style="list-style-type: none"> To test capacitive loads No instrument restart necessary 	<ul style="list-style-type: none"> Facilitates testing Limits number of connections to the DUT
Fully Automatic Test Sequences	<ul style="list-style-type: none"> To test according to IEEE or other standards 	<ul style="list-style-type: none"> Facilitates complex testing Facilitates test repetition
Real Time Display	<ul style="list-style-type: none"> To indicate instantaneous output voltage display. 	<ul style="list-style-type: none"> Facilitates testing
Load independent output	<ul style="list-style-type: none"> To indicate true symmetrical sinusoidal and square wave waveforms output 	<ul style="list-style-type: none"> Facilitates testing
Built in Memory	<ul style="list-style-type: none"> To save test sequences To save test reports 	<ul style="list-style-type: none"> Facilitates test repetition Facilitates documentation
Arc Management	<ul style="list-style-type: none"> To provide short-circuit protection To allow for fault conditioning 	<ul style="list-style-type: none"> Limits test interruptions commonly encountered when using conventional HV test instruments that immediately trip on arc detection.
Automatic load measurement	<ul style="list-style-type: none"> To limit connections to the DUT 	<ul style="list-style-type: none"> Facilitates testing
Intelligent Design	<ul style="list-style-type: none"> To avoid moving parts and need for lubrication 	<ul style="list-style-type: none"> Reduces maintenance Improves instrument durability and reliability
Instrument Lock-Key switch (7)	<ul style="list-style-type: none"> To prevent against unauthorized use 	<ul style="list-style-type: none"> Improves safety
Local and remote emergency off switches	<ul style="list-style-type: none"> To shutdown operations in emergency situation 	<ul style="list-style-type: none"> Improves safety
Fully integrated discharge and transient circuit	<ul style="list-style-type: none"> To ground the DUT after testing To protect the unit from transient over voltages 	<ul style="list-style-type: none"> Improves safety Protects instrument
Initial load clearance test at reduced voltages	<ul style="list-style-type: none"> To check automatically for shorts or grounds, during load measurement, before test initiation 	<ul style="list-style-type: none"> Improves safety
Return Voltage Indication	<ul style="list-style-type: none"> To monitor external high voltage greater than 100V (AC or DC) 	<ul style="list-style-type: none"> Improves safety
Discharge Status Indication	<ul style="list-style-type: none"> To indicate when DUT is not fully discharged. LED Red (3) lights when residual voltage greater than 100V 	<ul style="list-style-type: none"> Improves safety during normal disconnection procedures



3.3 Materials

Shipment Content

Items included upon delivery of the HVA are listed below. For inquiries, please contact HV Diagnostics.

Art. No.	Item	Description	Qty
	HVA120 HV Test Lead + Clamp 100kV / 10m / MC 14mm		1
GH0522	Earthing Cable Transparent 6mm ² / 4m; with 400A clamp		1*
GH0612	HV Emergency Adapter		1
KEC0007	Power On Key Spare key for Key switch (7)		1
KEK0017	Cable Serial DB9 f/f Link 3m		1
KEK0049	USB-RS232 Adapter FTDI USB Adapter UC232R-10		1
KDD0012	USB Stick Flash Drive HVD		1
DHV0067	HVA120 Operation Manual		1



NOTICE

Equipment Not included

Cables for remote control and external lamps are not supplied by HV Diagnostics!

Cable requirements:

- Twisted Pair; Rating: 600V;
- Dimensions: 18 gauge or 1mm²
- 2-pole to 5-pole cable

External Lamp requirements:

- Rating: Max 1.2 W
- Recommended colors: Red, Green

PINOUT Connection

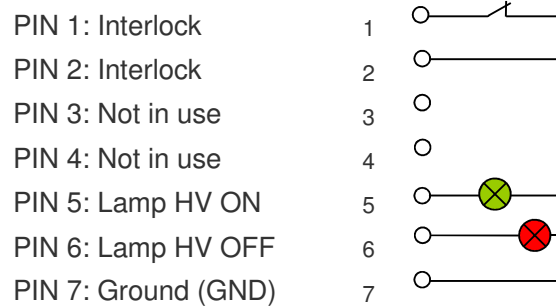



4 Design and Construction

4.1 Control Elements

HVA control and connection components are located on 2 panels

Panel- Orientation

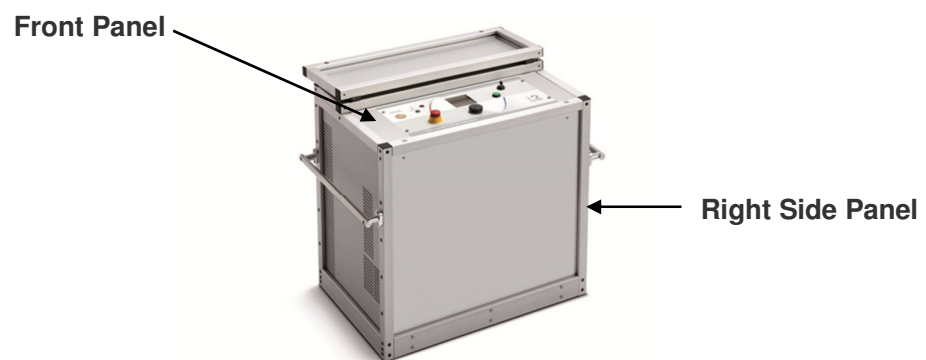

Orientation	Description
Front	<ul style="list-style-type: none">• Test controls and emergency shutdown• HV status information
Right Side	<ul style="list-style-type: none">• Cable and power source connections• External connections (for remote controls)• RS232 port / USB Flash Adapter

Switches and Controls

Front Panel



Pos.	Name	Description
1	Emergency OFF	Activates emergency shutdown. Operation is only possible when Emergency OFF is deactivated. <ul style="list-style-type: none"> To Activate Emergency Off → Press in To Deactivate Emergency Off → Release latch and rotate
2	LED green	Indicates HV status. * Green light indicates → High Voltage is OFF
3	LED red	Indicates HV status. * Red light indicates → High Voltage is ON (possible DANGER) → DUT not discharged (residual voltage >100V)
4	Display screen	Displays menu, options and status information.
5	Navigation knob	Enables user to select options and functions shown on display. See 4.2 User Interface <ul style="list-style-type: none"> To scroll selection up or down → Rotate To enter selection → Click (push in)
6	HV switch [on/off]	Activates high voltage. <ul style="list-style-type: none"> To activate HV output → Press within 10 seconds after START See 5.2 Manual Test Procedure: Step MR 2; See 5.3 Automatic Test Procedure: Step AR 6
7	Key switch [on/off]	Locks the unit to prevent against unauthorized use. <ul style="list-style-type: none"> To disable unit → Remove key from the OFF Position To reactivate unit → Replace key and turn to ON Position.



Switches and Controls, continued

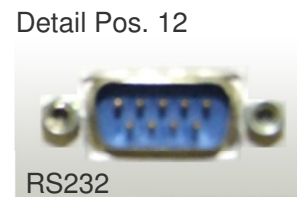
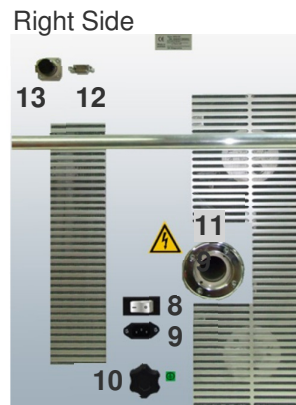

Pos.	Name	Description
8	Main switch [on/off]	Activates the HVA. This switch is a fuse with integrated magnetic auto-reset 16A <ul style="list-style-type: none">To reset → Turn the main switch OFF and then ON again
9	Power supply plug	Serves as connection point from the HVA to the 210V – 265V, 50/60 Hz powers source.
10	Earthing connector	Serves as connection point from HVA to earth.
11	HV output connector	Serves as connection point from the HVA to the HV test lead. To connect → Screw the HV test lead into the HV output connector and tighten
12	Communication port	Serves as connection point from the HVA to PC (via RS232) or to a USB device (via USB Flash adapter).
13	Remote control interlock plug	Provides interlock for the remote switch (i.e. door interlock). Can be connected to a remote emergency off switch, a gate, foot pedal or dead man switch



4.2 User Interface

Display Navigation

The navigation knob (5) enables the user to select or change options shown on the HVA display screen (4).

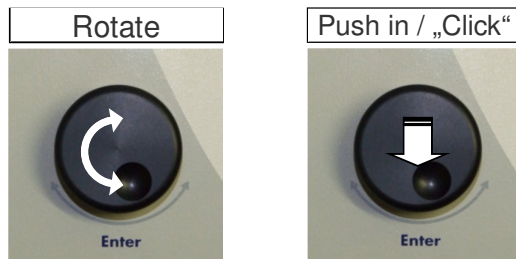

- To move to another item in a menu list or to any other field possible on the actual displayed screen → Rotate the knob.
- To scroll through options or to change value displayed of an active field → Rotate the knob.
- To select marked option or to accept set value accept → Push in / “click”

Display Contrast

The contrast of the HVA display screen (4) can be adjusted. The “Display Contrast” setting is found in the “Reports & Setup” menu.

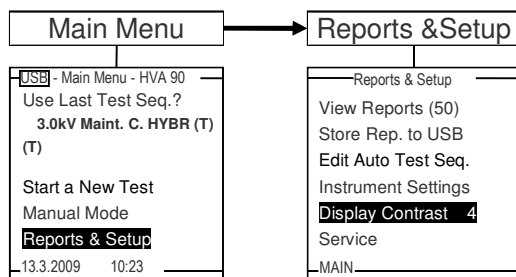

- The lowest value is “1”, refers to the lightest background.
- The greatest value “10” refers to the darkest background.

To select, Push in / “click” the navigation knob (5) until “Display Contrast” is highlighted. Rotate the knob to change the value. Push in / “click” in to enter the new value.



4.3 Instrument Set-up

The HVA instrument settings should be established prior to first utilization and can be modified at anytime thereafter. “Instrument Settings” is found in the “Reports & Setup” menu.

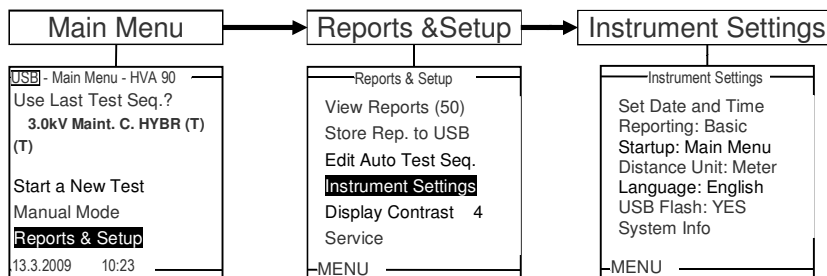

Description		
Setting	Options	Example
Set Date and Time	Select “Set Date and Time“ from “Instrument Settings “ menu to arrive at appropriate screen. “Clock Format” selected here appears in reports and on the Main Menu display hereafter: <ul style="list-style-type: none"> • 24h • am/pm 	
Reporting	“Reporting” type selected here is generated when report mode is active in testing hereafter. <ul style="list-style-type: none"> • Extended • Basic 	
Startup	“Startup” default screen selected here appears as 1 st screen when HVA is turned ON hereafter. <ul style="list-style-type: none"> • Main Menu • Manual Mode 	
Distance Unit	“Distance Unit” selected here sets the units for entering cable length when creating test parameters and reporting information hereafter. <ul style="list-style-type: none"> • Feet • Meter 	



Setting	Options	Example
Language	<p>“Language” selected here appears as display hereafter.</p> <ul style="list-style-type: none"> English 	<p>Instrument Settings Set Date and Time Reporting: Basic Startup: Main Menu Distance Unit: Meter Language: English USB Flash: yes System Info MAIN</p>
USB Flash	<p>“USB Flash” defines the status of communication port (12).</p> <ul style="list-style-type: none"> Flash :Yes (for USB Flash Adapter) Flash: No (for RS232) 	<p>Instrument Settings Set Date and Time Reporting: Basic Startup: Main Menu Distance Unit: Meter Language: English USB Flash: yes System Info MAIN</p>
System Info	<p>“System Info” displays HVA characteristics. This information cannot be modified by the operator:</p> <ul style="list-style-type: none"> Version: Installed HVA Hardware SN:HVA unit serial number Last Cal: Date of last calibration Ctrl.: Temperature 	<p>System Info Version 1.24.1 SN: 0123456789012 Last Cal. 12/02/2004 Ctrl. 80°F – PU 82°F MAIN</p>



4.4 Operation Modes

The following describes the scope of each HVA operation modes: **Test Modes**, **Output Modes** (Waveform), **Arc Management Modes**, and **Data Transfer Modes**.

Test Modes

The HVA can be operated in “Manual” or “Automatic” mode. For detailed procedure, see 5.2- Manual Test Mode, and 5.3 - Automatic Test Mode.

Test Mode	Characteristics
Manual	<p>Designed to facilitate rapid testing. Test Parameters of the last manual test appear as the default setting.</p> <ul style="list-style-type: none">• Test parameters can be changed immediately before activating a test.• Basic reporting most appropriate setting. (Extended reporting will generate a report with most fields left blank)
Automatic	<p>Designed for testing with predefined configuration in order to satisfy specific requirements (e.g. IEEE, IEC standards).</p> <ul style="list-style-type: none">• Test sequence must be configured and saved at any time before testing.• Extended reporting most appropriate setting.

Output Modes

The HVA can carry out HV test in the following output modes:

Output Mode	Characteristics
DC [- /+]	<p>Single polarity output. DUT is polarized (negative / positive) with respect to ground.</p> <ul style="list-style-type: none">• Not recommended for testing extruded cables (e.g. XLPE cables).• Measured valued: Dielectric loss of the DUT (including leakage current across terminations)• DC - : Most commonly used DC output mode
VLF Sinewave	<p>Default waveform</p> <ul style="list-style-type: none">• Suitable for testing extruded cables (e.g. XLPE cables).• Measured valued: RMS
VLF Squarewave	<ul style="list-style-type: none">• Suitable for testing extruded cables (e.g. XLPE cables).• Measured valued: RMS



Output Mode	Characteristics
Vacuum Bottle Testing	<ul style="list-style-type: none"> • Not suitable for testing with DC above DUT voltage rating (X-ray Hazard) • Possible in Manual and Automatic test modes • Trip current and rise rate are user defined • Measured valued: kV
Sheath Test	<ul style="list-style-type: none"> • Suitable for Sheath Test • Duration and Test voltage are user defined • max Test Voltage: 10 kV
Sheath Fault Location Mode	<ul style="list-style-type: none"> • Suitable for Sheath Fault Location • Duration is user defined • Pulse user defined (1:3 / 4 s, 1:5 / 4 s, 1:5 / 6 s, 1:9 / 6 s)

Arc Management Modes

If a fault is detected during a HV test, the arc management mode determines how the failure is managed. The “Burn on Arc” mode will condition the fault whereas the “Trip out on Arc” mode will immediately switch HV off.

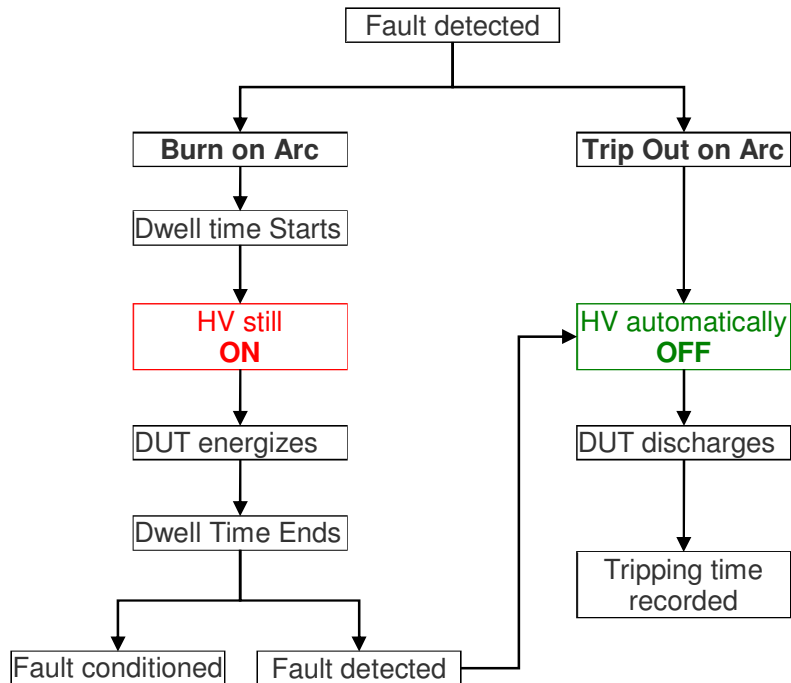



Data Transfer Modes

The HVA built in memory can save up to 50 reports and 40 test sequences. Data storage location and transfer capability depends on the configuration of the communication port (12).

Configuration	Characteristics
RS232 (standard)	<ul style="list-style-type: none">• During testing, RS232 cables are not connected to communication port (12)• Test sequences are directly saved to HVA memory• New reports are directly saved to HVA memory• All test sequences and reports saved in HVA memory ,can be transferred to the linked PC, once the HVA Control Center CD has been installed
USB Flash Adapter (optional)	<ul style="list-style-type: none">• During testing, USB adapter and stick are connected to communication port (12)• When connected, left hand corner of main menu displays “USB”.• Test sequences are directly saved to HVA memory• New reports are directly saved to USB stick inserted in adapter• Reports saved on the USB stick can be retrieved and viewed on the HVA display: <div style="text-align: center;"><pre>graph LR; MM[Main Menu] --> RS[Reports & Setup]; RS --> USB[USB]</pre></div> <ul style="list-style-type: none">• All reports saved in HVA memory, can be transferred to the linked USB stick: <div style="text-align: center;"><pre>graph LR; MM[Main Menu] --> RS[Reports & Setup]; RS --> USB[USB]</pre></div>



5 Test Procedure



DANGER

Electric Shock Hazard!

All procedures must comply with local safety regulations.

- Before operating the HVA, equipment set-up procedure must be completed!
- Cables must be connected in the proper sequence!
- Before, turning on the power supply and before activating the HVA, verify that all system elements are properly grounded!
See 5.1 Equipment Set-up: Steps S 1 –S 7

5.1 Equipment Set-up

Steps **S1-S9** describe the **Equipment Set-up** procedure. When carrying out multiple tests, the earth and power supply connections must always remain intact. The HV test lead must be reconnected before each subsequent test (i.e. repeat procedure as of step S3).

Cable Connection

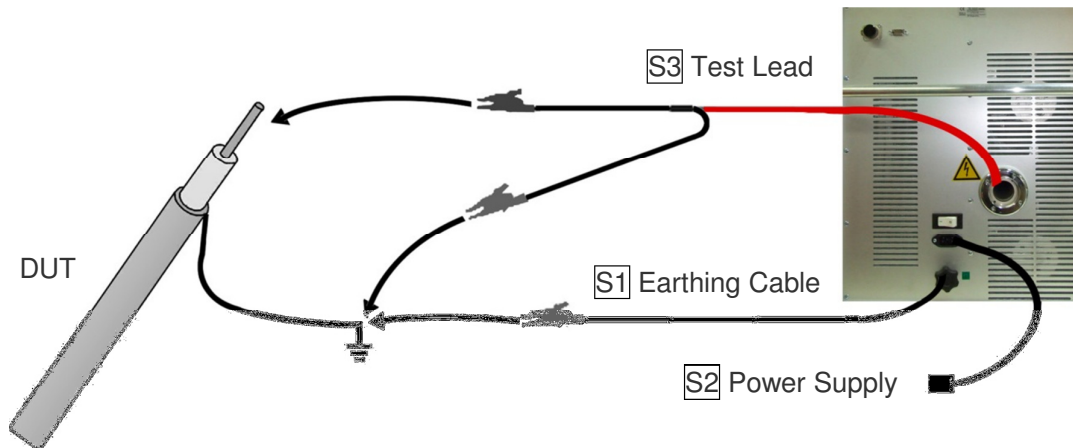

Step	Procedure
S1	<p>Connect Earthing Cable</p> <ul style="list-style-type: none"> • Connect earthing cable to the HVA earthing connector (10) • Connect earthing cable to the DUT ground
S2	<p>Connect Power Supply Cable</p> <ul style="list-style-type: none"> • Connect the power supply cable to the HVA power supply plug (9)
S3	<p>Connect HV Test Lead</p> <ul style="list-style-type: none"> • Screw the HV test lead into the HVA HV output connector (11) • Connect the HV cable shield to earth. • Connect other end of HV test lead (clamp including screen protector) to the DUT.



Step	Procedure
S4	Verify Connections <ul style="list-style-type: none">• Check that all cables are attached securely.
S5	Configure interlock plug (13) <ul style="list-style-type: none">• Verify that the HV emergency adapter is connected <p>If operating with remote controls (Optional):</p> <ul style="list-style-type: none">• Connect external lamps or remote switches• Refer to 3.3 –Materials for connection schema and material requirements
S6	Configure communication port (12) For USB Data Transfer Mode: <ul style="list-style-type: none">• Connect the USB Flash adapter• Insert USB stick <p>Otherwise: Verify that RS232 cable is not connected to the HVA!</p>
S7	Turn “ON” HVA main switch (8)
S8	Turn key switch (7) to the “ON” position
S9	The HVA system automatically boots. <ul style="list-style-type: none">• Start-up default screen appears “Main Menu” or “Manual Mode” screen See 4.3 Instrument Set-up <p>Select appropriate option from default screen and proceed to appropriate section for further instructions:</p> <ul style="list-style-type: none">• See 5.2 Manual Test Mode or See 5.3 Automatic Test Mode



5.2 Manual Test Mode

This HVA test mode facilitates rapid testing. If the default is the “Manual Mode Screen”, a test with the same settings as the previous test can be started directly after activating the system. Similarly, if the “Main Menu” is set as the 1st screen, select “Manual Mode”. Otherwise, select “Start a New Test” to change test parameters or to activate reporting.

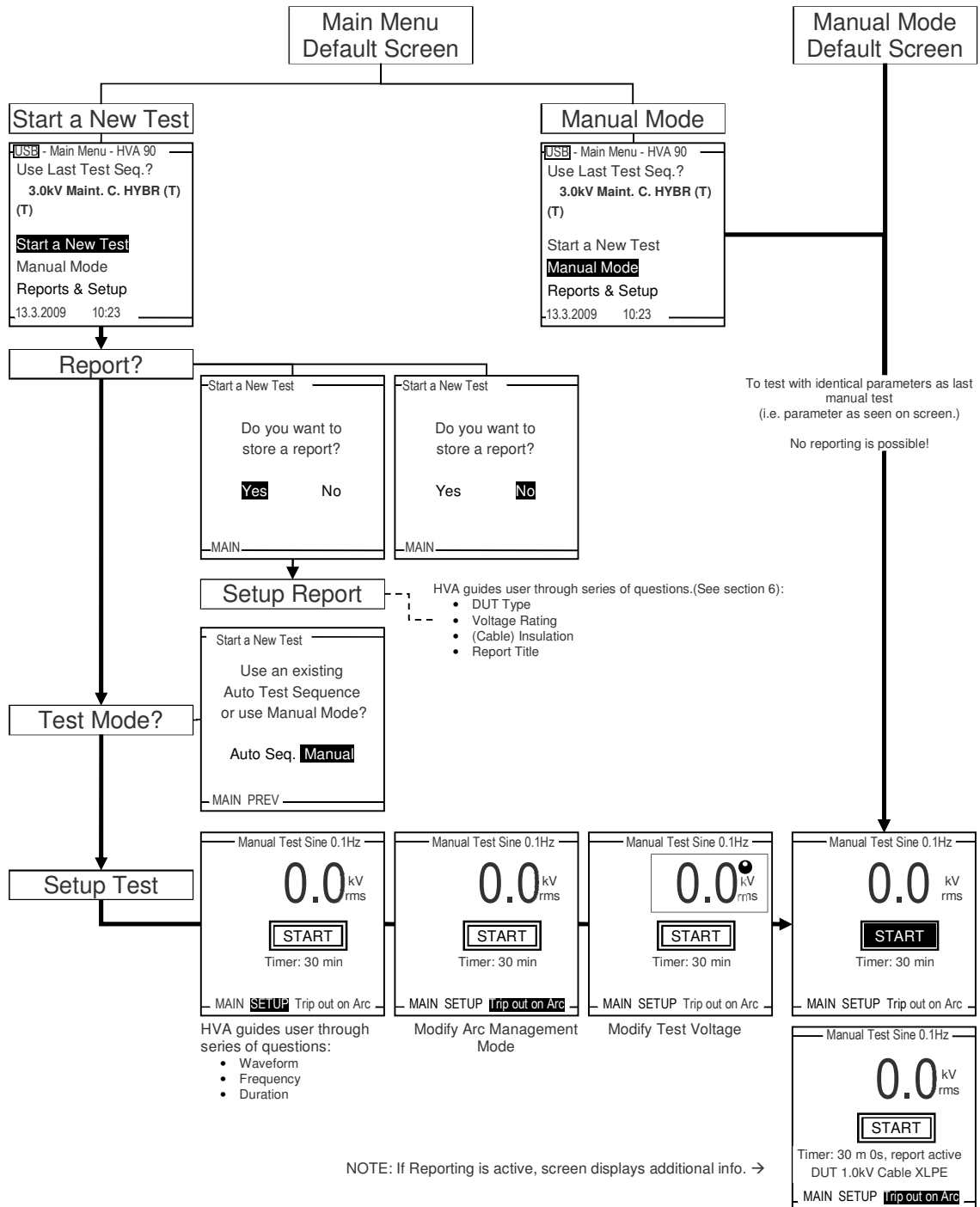



Setting Manual Test Parameters

Steps **MS 1-MS 6** describe how to **set manual mode test parameters**.

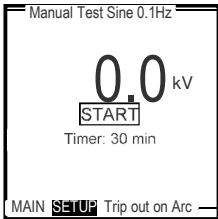
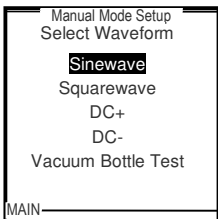
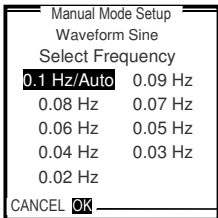
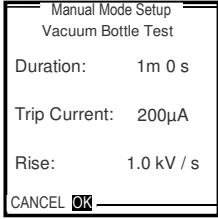
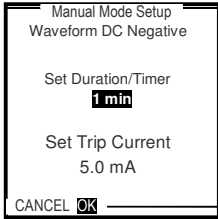
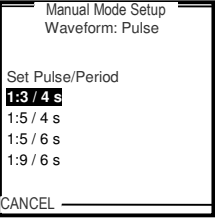
Step	Procedure (Set Manual Test Parameters)	Example
MS 1: SETUP	To set the waveform, frequency, or test duration, select "SETUP" on bottom of "Manual Test" screen	
MS 2: SETUP: Waveform	Select one of the following output modes: <ul style="list-style-type: none"> • Sine wave • Square wave • DC+ • DC- • Vacuum Bottle Test • Sheath Test • Sheath Fault Location 	
MS 3: Sinewave; Squarewave: SETUP: Frequency	Set the frequency to as close to 0.1Hz as possible. <ul style="list-style-type: none"> • 0.1 Hz/Auto: Recommended setting that automatically maintains the frequency as close to 0.1Hz as possible To correct entry select "CANCEL" at bottom of display.	
MS 4: Vacuum Bottle Test: SETUP: Trip Current Rise Rate	Set the test "Duration": <ul style="list-style-type: none"> • Min. = 5 seconds; Max. = 15 minutes Set the test "Trip Current": <ul style="list-style-type: none"> • Min. = 200µA, Max. = 1000µA Set the test "Rise" rate: <ul style="list-style-type: none"> • Min. = 0.5 kV/s, Max. = 5.0 kV/s 	
MS 5 Sheath Test	Set the test "Duration/Timer": <ul style="list-style-type: none"> • Min. = 1 minute; Max. = 15 minutes Set the test "Trip Current": <ul style="list-style-type: none"> • Min. = 0.1 mA, Max. = 5.0 mA 	
MS 6: Sheath Fault Location	Select one of the following Pulse/Periods: <ul style="list-style-type: none"> • 1:3 / 4 s • 1:5 / 4 s • 1:5 / 6 s • 1:9 / 6 s For example: 1 second on and 3 seconds off, every 4 seconds.	



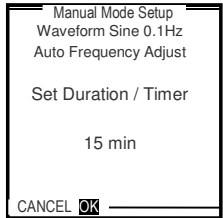
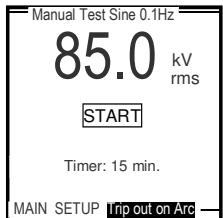
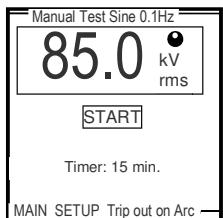

Step	Procedure (Set Manual Test Parameters)	Example
<p>MS 7: SETUP: Duration (Not applicable Vacuum Bottle Test)</p>	<p>To modify the duration, rotate navigation knob (5). To accept value, push in knob.</p> <ul style="list-style-type: none"> Min. test duration = 1 minute Max. test duration = 24 hours <p>To return to “Manual Mode” screen, select “OK”</p>	
<p>MS 8: Arc Management Mode</p>	<p>Rotate navigation knob (5) until the field on bottom of the screen is highlighted. To change the mode, push in the knob. One of the following modes will be displayed:</p> <ul style="list-style-type: none"> Trip out on Arc Burn on Arc 	
<p>MS 9: Preset Test Voltage: (optional-voltage can be set once test has been initiated!)</p>	<p>Entering the test voltage before activating the manual mode test “START” is optional. In manual mode, voltage can be set once test has been initiated! To set the test voltage before activating the manual mode test “START”:</p> <p>Rotate navigation knob (5) until voltage field is framed. The dot in upper right hand corner indicates that the test voltage is in preset mode. To modify the value, rotate navigation knob (5).</p> <ul style="list-style-type: none"> Min. test voltage = 0.0kV Max. voltage = 85.0kV rms (VLF), 100.0kV (DC) <p>To accept the value, push in knob (5).The dot in upper right hand disappears indicating that the test voltage is set.</p>	

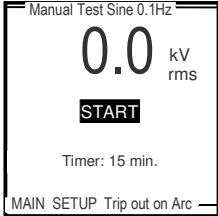

Running a Manual Test

Steps **MR 1-MR 6** describe how to **run a test in the manual mode**.

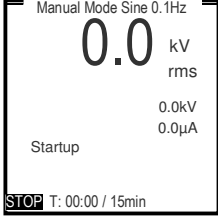
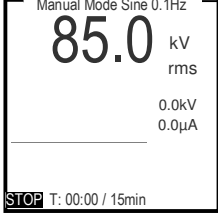
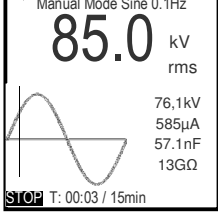
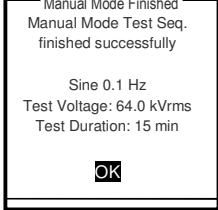
Step	Procedure (Run Manual Test)	Example
MR 1: START	Start the test when test parameters displayed on the “Manual Test” screen are correct. Rotate navigation knob (5) until the “START” field is highlighted. <ul style="list-style-type: none">To run the test, push in knob (5)	
MR 2: HV Activation	Once the activation screen appears, <ul style="list-style-type: none">Press the HV switch (6) within 10 seconds. <p>If the HV switch is not activated within the 10 second window, the “Manual Mode” screen will reappear.</p>	
MR 3: Test Start up	“Startup” appears on the screen to indicate that the HVA is initializing the test	
MR 4: Set Test Voltage (if not preset in step MS 6)	Rotate navigation knob (5) to modify the voltage value. <ul style="list-style-type: none">Min. test voltage = 0.0kVMax. voltage = 85.0kV rms (VLF), 1000.0kV (DC)	
MR 5: Test	Test begins automatically The bottom of the screen indicates the lapsed time <ul style="list-style-type: none">T: lapsed time / total test duration	
MR 6: Test End	Display indicates end of Manual Test	



5.3 Automatic Test Mode

This HVA test mode facilitates testing in order to satisfy specific requirements (e.g. IEEE, IEC standards). The test sequence can be configured, modified and saved at any time before testing.

Configuring Auto Test. Sequence- Overview

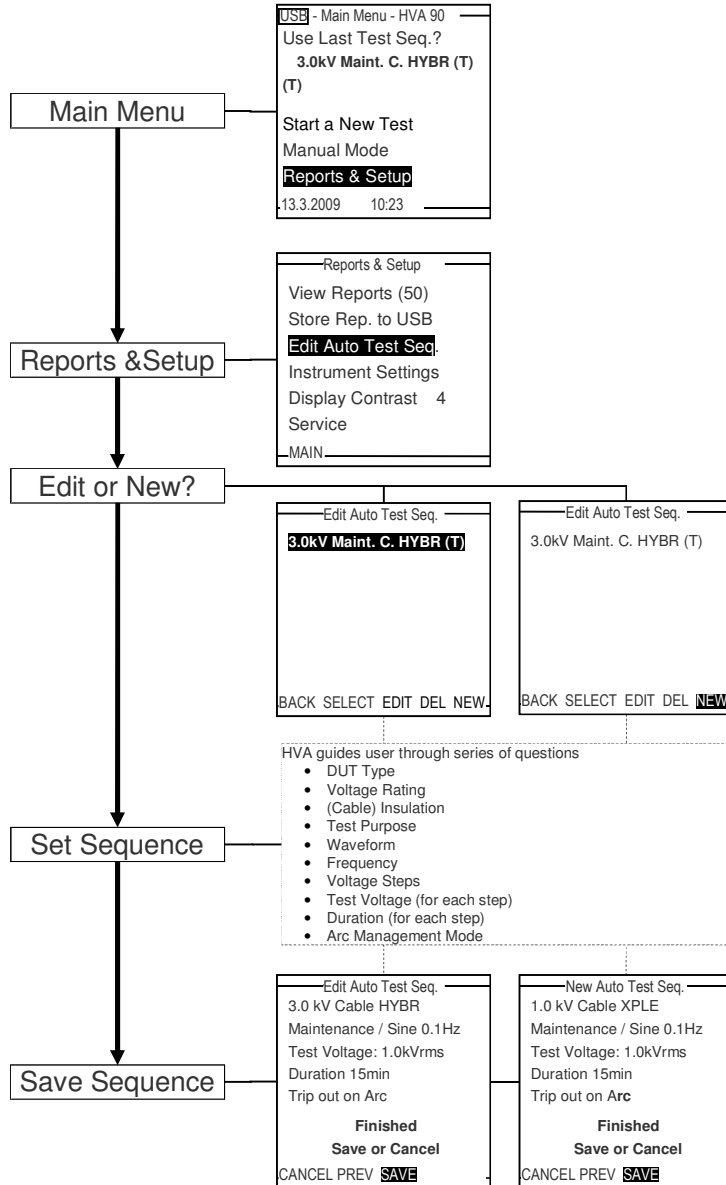



Configuring Auto Test. Sequence- Detailed Steps

Steps **AS 1-AS 15** describe how to **configure a test sequence**.

Step	Procedure (Configure Automatic Sequence)	Example
AS 1: EDIT or NEW?	<p>The “Edit Auto Test Seq”. Menu displays the sequences already stored in memory.</p> <ul style="list-style-type: none"> To modify an existing program, highlight the corresponding program from the list and select the “EDIT” option, on the bottom of the screen To create a new program, select the “NEW” option, on the bottom of the screen 	
AS 2: DUT	<p>Select one of the following DUT types:</p> <ul style="list-style-type: none"> Cable Motor Generator Transformer Switchgear Other Vacuum Bottle 	
AS 3: Voltage Rating	<p>Specify the voltage rating of the DUT. This is a characteristic of the DUT and does NOT refer to the test voltage! To increase / decrease the voltage rating, rotate navigation knob (5). To accept value, push in knob.</p> <ul style="list-style-type: none"> Min. rating = 0.1 kV, Max. rating = 110.0 kV 	
AS 4: (Cables Only) Insulation	<p>Select one of the following cable insulation types:</p> <ul style="list-style-type: none"> XLPE PILC EPR PE PVC HYBRID (combination of types) OTH. (other) 	
AS 5: Test Purpose	<p>Select aim of test from one the following:</p> <ul style="list-style-type: none"> Acceptance Maintenance Diagnostic 	
AS 6: Waveform	<p>Select one of the following output modes:</p> <ul style="list-style-type: none"> Sine wave Square wave DC+ DC- Vacuum Bottle Test 	



Step	Procedure (Configure Automatic Sequence)	Example
AS 7: Frequency (Sinewave or Squarewave only)	Set the frequency to as close to 0,1Hz as possible. <ul style="list-style-type: none"> 0.1 Hz/Auto: Recommended setting that automatically maintains the frequency as close to 0.1Hz as possible Permitted values: 0.02 -0.1Hz in 0.01 Hz increments 	
AS 8: Voltage Steps	Specify the number of voltage steps to be applied to the DUT. <ul style="list-style-type: none"> Min. voltage levels: 1 Step Max. voltage levels: 4 Steps 	
AS 9: Test Voltage	Specify test voltage for each step: <ul style="list-style-type: none"> Min. voltage = 0.1 kV Max. voltage = 85.0 kV rms (for VLF) = 1000 kV (for DC) For multiple voltage steps: HVA automatically advances to next step. Values are displayed in a table.	
AS 10: Duration	Specify test duration for each step: <ul style="list-style-type: none"> Min. test duration / step = 1 minute Max. test duration / step = 120 minutes For multiple voltage steps: HVA automatically advances to next step. Values are displayed in a table.	
AS 11: Arc Management Mode	Select one of the following arc management modes: <ul style="list-style-type: none"> Trip out on Arc Burn on Arc 	
AS 12 (Vacuum Bottle Only) Trip Current	Set the test "Trip Current": <ul style="list-style-type: none"> Min. = 200µA, Max. = 1000µA 	

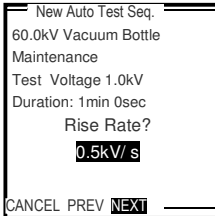
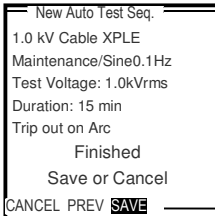
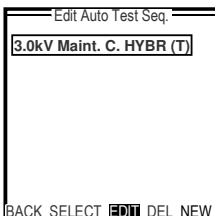
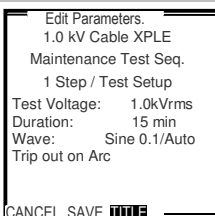
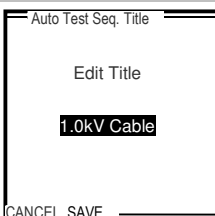

Step	Procedure (Configure Automatic Sequence)	Example
AS 13 (Vacuum Bottle Only) Rise Rate	Set the test “Rise” rate: <ul style="list-style-type: none"> • Min. = 0.5 kV/s • Max. = 5.0 kV/s 	
AS 14: Save Sequence	Test sequence setup is complete. <ul style="list-style-type: none"> • To save the program select “SAVE”. The program will be stored under a name referring to its test parameters.(To modify name, see AS15) The sequence is found in the “Edit Auto Test Seq.” Menu display. See Step AS 1.	
AS 15: (optional) Edit Sequence Title	To modify the sequence title from program already saved in HVA memory, highlight the corresponding sequence from the “Edit Auto Test Seq.”. Menu display. <ul style="list-style-type: none"> • select the “EDIT” option, on the bottom of the screen 	
	<ul style="list-style-type: none"> • select the “TITLE” option, on the bottom of the screen 	
	For naming directions, see 6-Reporting Procedure-Report Naming Instructions	



Running an Automatic Test - Overview

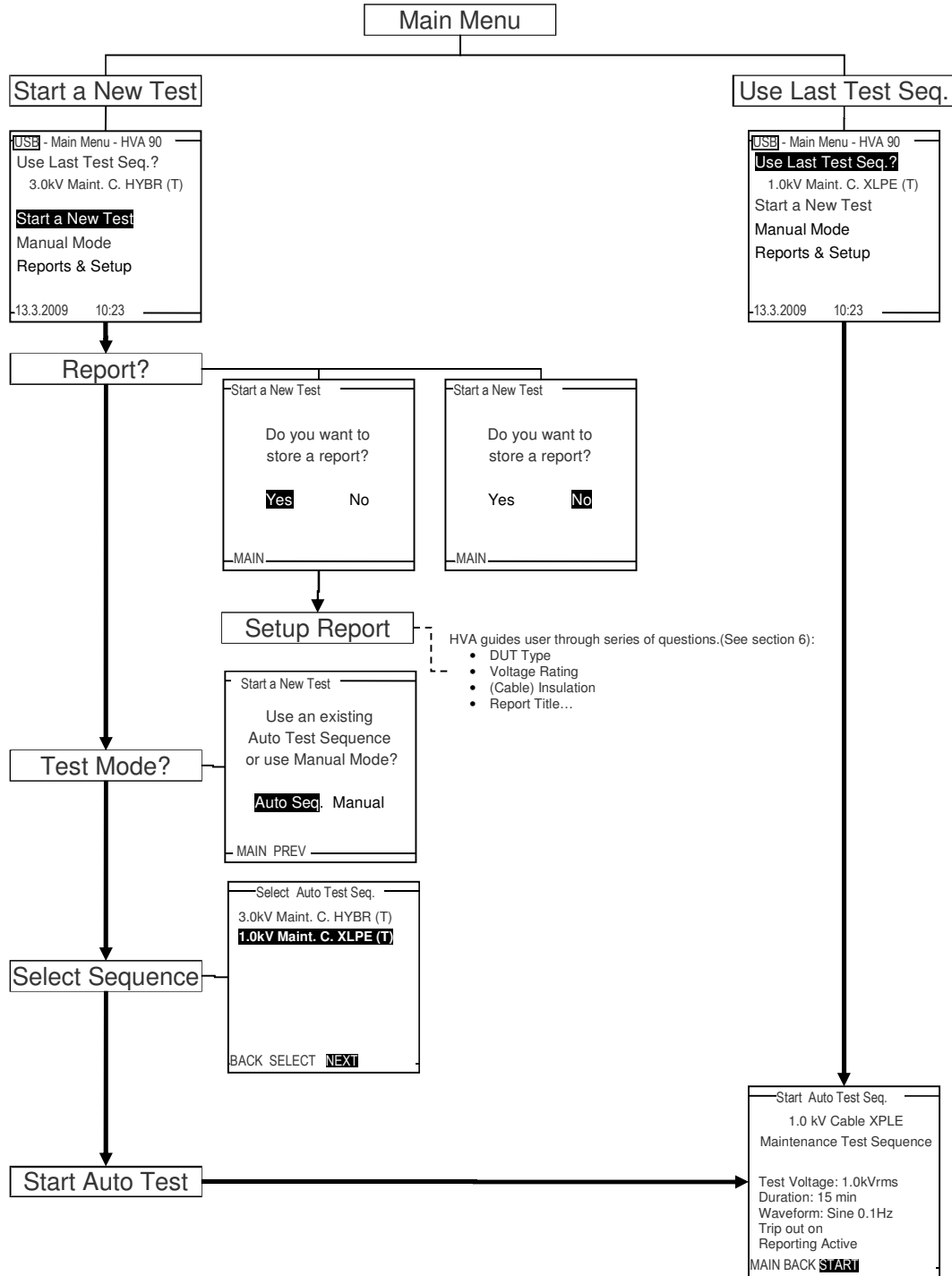



Running an Automatic Test - Detailed Steps

Steps **AR 1-AR 9** describe how to **run a test in the Automatic Mode.**

Step	Procedure (Run Automatic Test)	Example
AR 1: Use Last Seq. or Start New Test	To repeat the previous test sequence: <ul style="list-style-type: none"> • Select “Use Last Test Sequence” from “Main Menu” • Proceed to Step AR 5 Otherwise, select: <ul style="list-style-type: none"> • “Start a new Test” 	
AR 2: De / activate Reporting	To activate reporting: <ul style="list-style-type: none"> • Select “YES”, See 6 Reporting To conduct a test without generating a report: <ul style="list-style-type: none"> • Select “NO” 	
AR 3: (If reporting active: this step follows report setup completion)	To run an test sequence: <ul style="list-style-type: none"> • Select “Auto Seq” 	
AR 4: Select Sequence	<ul style="list-style-type: none"> • Select the appropriate test sequence • To continue, select “NEXT” 	
AR 5: Parameter Verification	<ul style="list-style-type: none"> • Verify that the selected sequence defines the correct test parameters To run the auto test sequence: <ul style="list-style-type: none"> • Select “START” from the bottom of the screen 	
AR 6: HV Activation	Once the activation screen appears, <ul style="list-style-type: none"> • Press the HV switch (6) within 10 seconds. If the HV switch is not activated within the 10 second window, the “Start Auto Test Seq.” screen will reappear.	



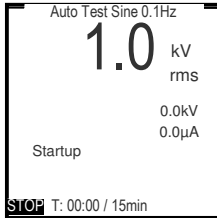
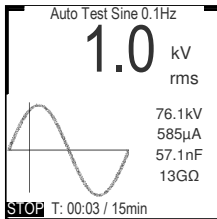
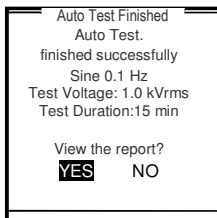

Step	Procedure (Run Automatic Test)	Example
AR 7: Test Start up	“Startup” appears on the screen to indicate that the HVA is initializing test	
AR 8: Test	Test begins automatically The bottom of the screen indicates the lapsed time <ul style="list-style-type: none"> • T: lapsed time / total test duration 	
AR 9: Test End	Display indicates end of Auto Test If reporting is active, the user can immediately view the report.	

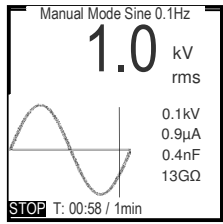
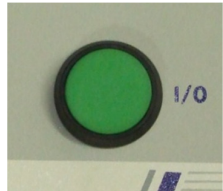

5.4 Interrupting a Test

Once a test has started, it can be interrupted at any time. It is recommended to select the appropriate method corresponding to the situation

Situation	Procedure	Example
Routine STOP (No emergency)	When a test is in progress, "STOP" on the display screen is highlighted. To interrupt the test, push in / click the navigation knob (5) <ul style="list-style-type: none">• HVA software deactivates HV• Test stops	
Alternative	When a test is in progress, press the HV switch (6) to deactivate high voltage. <ul style="list-style-type: none">• HVA hardware deactivates HV• Test stops	
Emergency Stop	In an emergency situation, press the Emergency Off (1) to shutdown the system. <ul style="list-style-type: none">• HVA hardware deactivates HV• Test stops	

After test interruption, a message is displayed indicating that the test has been terminated by the user:

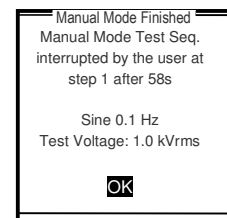



6 Reporting Procedure

Report Type

The HVA can generate 2 report types: A “Basic” report with limited information, or a more complete “Extended” report. The type of report generated corresponds to the entry selected in “Instrument Settings”. Before testing, verify that the desired type is set!

See 4.3: Instrument Set-up

Report Info.	Basic	Extended
DUT Type	✓	✓
Voltage Rating	✓	✓
(Cable) Insulation Type	✓	✓
Report Title	✓	✓
Phase name		✓
Company name		✓
Region name		✓
Station name		✓
Line Length		✓
Size of DUT		✓
Manufacturer		✓
Work order		✓
Operator name		✓

Report Activation

Reporting is possible in both the test modes. To generate a report in the manual mode, the procedure must begin with “Start a New Test” from the main menu. See 5.2-Manual Test Mode

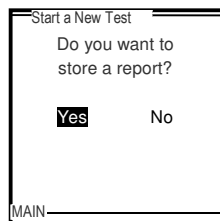



Report Naming Instructions

To enter the report information, some steps (i.e. steps R4-R13) require the operator to enter a user selected name. If no name is entered, the corresponding category appears blank in the report.

Possible entries include:

- A B C D E F G H I J K L M N O P Q R S T U V W X Y Z
- . , ; : " # - + /
- 0 1 2 3 4 5 6 7 8 9

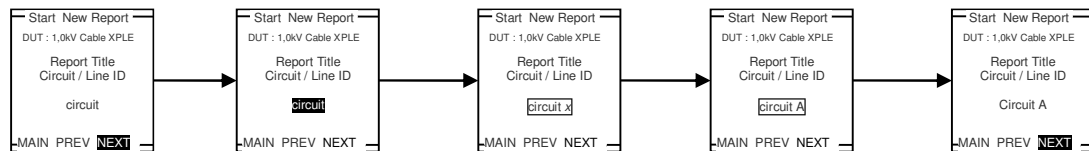

- To activate naming: Rotate Navigation Knob (5), then Push in/click.
- To select characters: Rotate Knob (5) clockwise
- To DELETE: Rotate Knob (5) counter clockwise until < symbol appears
- To SPACE: Rotate Knob (5) counter clockwise until _ symbol appears
- To confirm: double click Knob (5)

Entering Report Information



The HVA guides the user through a series of questions dependant on the report type already set in “Instrument Settings”. These steps are independent of the test mode, as the user has not yet selected “Manual” or “Automatic”. Note that although some of the following steps (i.e. R1 – R3) require entry of identical information as in “Configuring Auto Test. Sequence” (i.e. steps AS 2, AS 3 and AS 4), these steps are not identical!

Steps **R 1-R 13** lists the **report information** that the HVA asks the user to enter when the “Extended” reporting mode is active.

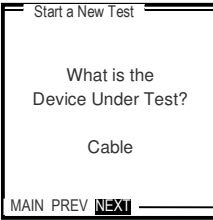
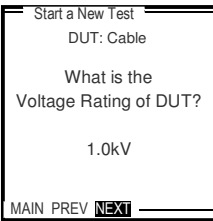
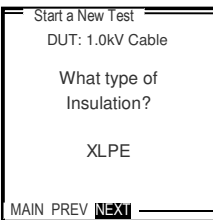
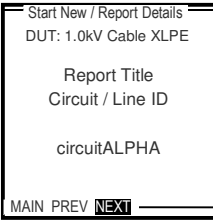
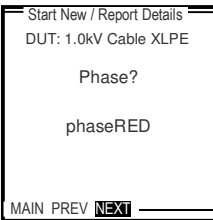
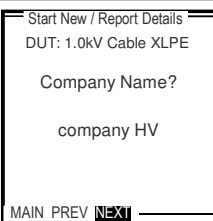
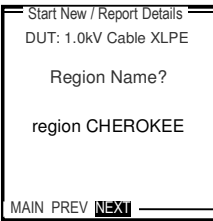

Step	Procedure (Reporting)	Example
R 1: DUT	Specify the type of DUT. Select one of the following options: <ul style="list-style-type: none"> • Cable • Motor • Generator • Transformer • Switchgear • Other • Vacuum Bottle 	
R 2: Voltage Rating	Specify the voltage rating of the DUT. This is a characteristic of the DUT and does NOT refer to the test voltage! Rotate navigation knob (5) to increase or decrease voltage rating value: <ul style="list-style-type: none"> • Min rating. = 0.1 kV; Max rating= 110.0 kV 	
R 3: Insulation (only applicable for Cables)	Specify one of the following cable insulation types: <ul style="list-style-type: none"> • XLPE • PILC • EPR • PE • PVC • HYBRID (combination of types) • OTH. (other) 	
R 4: Report Title	Set report name <ul style="list-style-type: none"> • User defined entry, typically the cable number or ID for cable testing 	
R 5: Phase (Extended only)	Specify circuit phase <ul style="list-style-type: none"> • User can define up to 3 phases if required 	
R 6: Company (Extended only)	Specify company name	
R 7: Region (Extended only)	Specify region name	

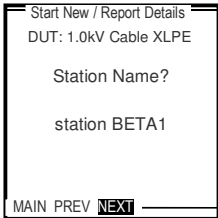
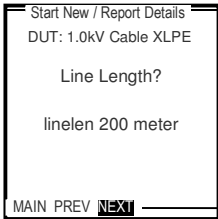
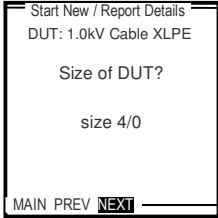

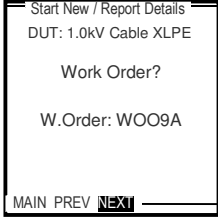
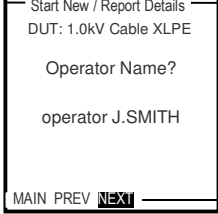
Step	Procedure (Reporting)	Example
R 8: Station (Extended only)	Specify station name	
R 9: Line Length (Extended only)	Specify line length <ul style="list-style-type: none">Units correspond to “Distance Unit” set in “Instrument Settings” (see 4.3-Instrument Set-up)	
R 10: DUT size (Extended only)	Specify DUT size Typical entries include: <ul style="list-style-type: none">Conductor size for cable testHorsepower or kW for motor test	
R 11: Manufacturer (Extended only)	Specify manufacturer name	
R 12: Work Order (Extended only)	Specify work order name	
R 13: Operator (Extended only)	Specify operator name	



Step	Procedure (Reporting)	Example
End of reporting procedure	<ul style="list-style-type: none"> To continue in Manual Test Mode : See 5.2 Steps MS 1-MS 5- set test parameters Steps MR 1-MR 6- run test 	
Select Test Mode	<ul style="list-style-type: none"> To continue in Automatic Test Mode: See 5.3 Steps AS 1-AS 15- configure sequence Steps AR 1-AR 9- run test 	

Viewing Report

Reports can be viewed directly on the HVA display screen. In “Reports & Setup” the number of reports saved appears in parentheses following “View Reports”. Reports are listed according to date, with the first entry corresponding to the latest report saved.

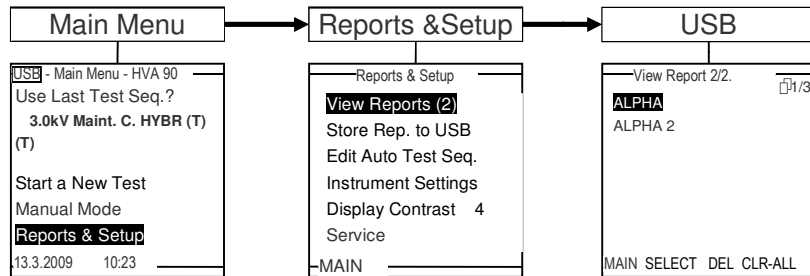

When a report is selected, the screen header indicates:
“Reference # of report in view / Total number of reports saved”.

The upper right-hand corner displays:
“Page # in view / Total number of report pages”.

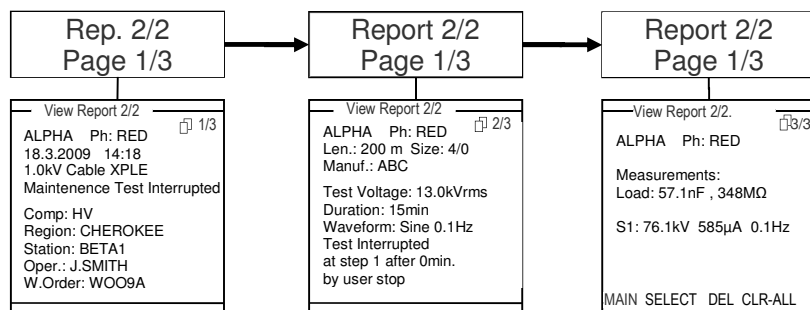



7 Disconnection Procedure



DANGER

Electric Shock Hazard

Never assume that equipment is safe to handle without using the necessary safety equipment and earthing procedures.

Disconnection procedures must comply with local safety regulations.

- Before disconnecting test lead, DUT must be discharged and earthed.
- Earth connections must be removed last!

Disconnection

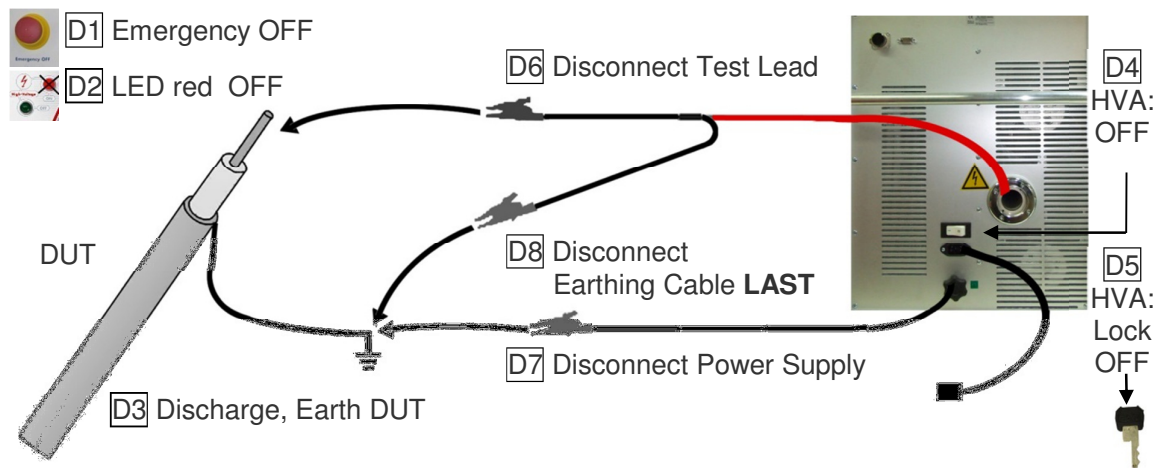

Normal Conditions

Steps **D 1- D 8** describe the **normal disconnection** procedure.

Step	Procedure (Normal Disconnection)
D1	Press Emergency OFF (1)
D2	Verify HV status <ul style="list-style-type: none"> • Wait until LED red (3) light deactivates (indicates residual voltage < 100V)
D3	Discharge and earth the DUT complying with local safety regulations
D4	Turn OFF HVA <ul style="list-style-type: none"> • Turn the HVA main switch (8) off
D5	Lock HVA in disabled state to prevent against unauthorized use: <ul style="list-style-type: none"> • Turn Key switch (7) to OFF Position and remove Key
D6	Disconnect the Test Lead <ul style="list-style-type: none"> • Disconnect the test lead from the DUT • Unscrew the test lead from the HV output connector (11)
D7	Disconnect power supply cable from power supply plug (9)
D8	Disconnect Earth <ul style="list-style-type: none"> • Disconnect the earthing cable from the HVA earthing connector (10) • Disconnect the earthing cable from the DUT.



System Failure

In case of errors or failure due to a loss of power during testing, additional precaution is required. The HVA LED red (3) light cannot indicate when residual voltage is less than 100V. To guarantee that the residual voltage has dissipated before removing the test lead, the DUT must be de-energized using a discharge stick.

Steps **D 1*-D 7*** describe the **disconnection** procedure in case of **system failure**.

Step	Procedure (System Failure Disconnection)
D1*	Switch HVA OFF <ul style="list-style-type: none">• Press Emergency OFF (1)• Turn the HVA main switch (8) off• Lock HVA in disabled state to prevent against unauthorized use: Turn Key switch (7) to OFF Position and remove Key
D2*	<ul style="list-style-type: none">• Verify correct functioning of discharge stick
D3*	Discharge and earth the DUT complying with local safety regulations <ul style="list-style-type: none">• Discharge DUT using a discharge stick
D4*	Before disconnecting test lead, wait until residual voltage has dissipated. <ul style="list-style-type: none">• Required wait time depends on the resistance of the discharge stick.• Rule of thumb: For standard discharge sticks, wait a minimum of 10 min.
D5*	Disconnect the Test Lead <ul style="list-style-type: none">• Disconnect the test lead from the DUT• Unscrew the test lead from the HV output connector (11)
D6*	Disconnect power supply cable from power supply plug (9)
D7*	Disconnect Earth <ul style="list-style-type: none">• Disconnect the earthing cable from the HVA earthing connector (10)• Disconnect the earthing cable from the DUT.



8 Instrument Care

Cleaning



DANGER

Electric Shock Hazard!

Only clean the instrument when turned off!

After use, clean the HV Cable connection points.

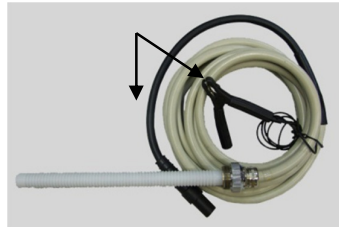

Storage



CAUTION

Instrument Damage

Do not store the HVA outdoors!
Keep the HVA away from liquids!

HVA should be stored indoors in the following environmental conditions:

- Temperature: -25°C to 70°C (-13F to 158F)
- Humidity: 5-85% non condensing

Maintenance and Repairs



NOTICE

Authorized personnel only!

Repairs and maintenance should only be performed by authorized HV Diagnostics personnel.





One yearly inspection by authorized HV Diagnostics personnel is recommended.



9 Accessories

Accessories are not included upon standard delivery of the HVA. These items are available for order through HV Diagnostics. For orders, please contact HV Diagnostics.

Art. No.	Item	Description
GH0602	USB Flash Adapter	
SH0236	PD90-2 Partial Discharge Fault Location System 90kV	
SH0237	PDTD90-2 Partial Discharge Fault Location System 90kV with Tangens Delta	



10 Glossary and Abbreviations

The following explains abbreviations and selected terms used in this document in alphabetical order.

Term	Explanation
Arc	Self-maintained gas conduction for which most of the charge carriers are electrons supplied by primary-electron emission (source: IEC)
Auto Adjust Frequency "0.1 Hz/Auto"	Mode that maximizes output frequency to highest allowable value <ul style="list-style-type: none">• Greatest allowable frequency depends on the test load and test voltage applied• For loads greater than 1μF, the instrument automatically reduces the frequency
DUT	Device under Test
Duty (continuous)	Load state in which the relay remains energized for a period long enough to reach thermal equilibrium
Fault	An unplanned occurrence or defect in an item which may result in one or more failures of the item itself or of other associated equipment (source: IEC)
Frequency[Hz]	Number of cycles per unit of time ; $f=1/$ Period (Time), units=Hz 1Hz = 1cycle / 1 second 0.1 Hz = 1cycle / 10 second , etc.
Hipot	High potential (voltage)
HV	High Voltage (tension) <ul style="list-style-type: none">• Extremely high voltage: typically 220kV or 380kV• High voltage: typically 110kV
IEC	International Electrotechnical Commission
Peak value	Maximum Voltage = V_{max}
RMS value	Root Mean Square voltage <ul style="list-style-type: none">• $V_{rms} = V_{max} / \sqrt{2}$
To Short	Forcing the electric potential differences between two or more conductive parts to be equal to or close to zero (Infinite current flows in a short circuit)
To Trip	Opening the circuit (no current flows in open circuit)
VLF	Very Low Frequency <ul style="list-style-type: none">• Typically between 0.01 -0.1 Hz

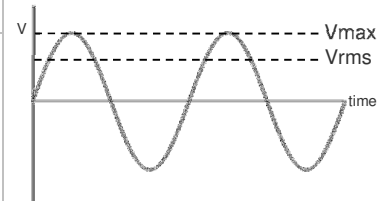



11 Declaration of Conformity

The HVA120 is CE certified and has met the following requirements of the European Council:

Category	Standard
EMC	IEC61004-2 , ESD Level 4 (8/15kV) IEC61004-4 , Burst 4kV 5kHz EN55011
Safety	EN60950 EN50191 EN61010-1